



IR detection module
VPAC-1000F
user's guide

Table of Contents

1. Warranty.....	3
2. VPAC-1000F technical information.....	4
2.1. Module physical dimensions.....	4
2.2. Beam power limitation.....	5
2.3. Preamplifier supply voltage.....	6
2.4. Preamplifier load resistance.....	6
2.5. Thermoelectric cooler parameters.....	6
2.6. Thermistor.....	6
2.7. Supply socket.....	7
3. Getting started (regards the module itself as well as the complete IR detecting kit).....	8
3.1. Unpacking.....	8
3.2. Installation & connections.....	8
3.3. Switching on procedure.....	9
4. VPAC-1000F other related information.....	10
4.1. CE statement of conformity	10
4.2. Electromagnetic interference.....	10
4.3. Operating temperature and heat sinking.....	10
4.4. Storage information.....	10
5. Safety instructions.....	11
6. Troubleshooting.....	12
6.1. List of the possible faults and solutions.....	12
6.1.1. The LOCK LED on the TEC controller's does not light	12
6.1.2. Too high DC level at the output of the preamplifier.....	13
6.1.3. Too high current consumption by the preamplifier.....	13
6.1.4. No or too weak response to optical radiation.....	13
6.1.5. Excess noise.....	14
6.1.6. Unstable signal.....	14
6.1.7. Long signal rise/fall time.....	14



1. Warranty

VIGO System S.A. hereby represents and warrants all Products manufactured by VIGO and sold hereunder to be free from defects in workmanship or material during a period of twelve (12) months from the date of delivery save for products for which a special warranty is given. If any Product proves however to be defective in workmanship or material within the period herein provided VIGO System undertakes to the exclusion of any other remedy to repair or at its own option replace the defective Product or part thereof free of charge and otherwise on the same conditions as for the original Product or part without extension to original warranty time. Defective parts replaced in accordance with this clause shall be placed at the disposal of VIGO.

VIGO also warrants the quality of all repair and service works performed by its employees to products sold by it. In case the repair or service works should appear inadequate or faulty and should this cause malfunction or nonfunctioning of the product to which the service was performed VIGO shall at its free option either repair or have repaired or replace the product in question. The working hours used by employees of VIGO for such repair or replacement shall be free of charge to the client. This service warranty shall be valid for a period of six (6) months from the date the service measures were completed.

This warranty is however subject to following conditions:

1. A substantiated written claim as to any alleged defects shall have been received by VIGO System within thirty (30) days after the defect or fault became known or occurred, and
2. The allegedly defective Product or part shall, should VIGO so require, be sent to the works of VIGO or to such other place as VIGO may indicate in writing, freight and insurance prepaid, properly packed and labeled.

This warranty does not however apply when the defect has been caused through

1. normal wear and tear or accident;
2. misuse or other unsuitable or unauthorized use of the Product or negligence or error in storing, maintaining or in handling the Product or any equipment thereof;
3. wrong installation, assembly or failure to service the Product or otherwise follow VIGO's service instructions including any repairs or installation or assembly or service made by unauthorized personnel not approved by VIGO or replacements with parts not manufactured or supplied by VIGO;
4. modifications or changes of the Product as well as any adding to it without VIGO's prior authorization;
5. burned active element by irradiation above damage thresholds
6. electrostatic discharges
7. improper detector bias
8. improper TE cooler bias (TE cooler damage or active element overheating).
9. other factors dependent on the Customer or a third party.

Notwithstanding the aforesaid VIGO System liability under this clause shall not apply to any defects arising out of materials, designs or instructions provided by the Customer.

This warranty is expressly in lieu of and excludes all other conditions, warranties and liabilities, expressed or implied, whether under law, statute or otherwise, including without limitation any implied warranties of merchantability or fitness for a particular purpose and all other obligations and liabilities of VIGO or its representatives with respect to any defect or deficiency applicable to or resulting directly or indirectly from the Products supplied hereunder, which obligations and liabilities are hereby expressly canceled and waived. VIGO's liability shall under no circumstances exceed the invoice price of any Product for which a warranty claim is made, nor shall VIGO in any circumstances be liable for lost profits or other consequential loss whether direct or indirect or for special damage.

RMA Request Instructions:

No Product may be returned without first contacting VIGO for a Return Material Authorization ('RMA') number. Please obtain a RMA number at claim@vigo.com.pl before returning any item. When requesting a RMA number, please state your order number, the product you wish to return and the reason for return. We will only accept returns which have a RMA number. Authorized returns are to be shipped according to received instruction from VIGO in appropriate shipping box. An unauthorized return, i.e. one for which an RMA number has not been issued and authorized returns however, shipped with incorrect customs documents - will not be accepted.

Please print the RMA number clearly on the return label to avoid any delay in processing. Please send package to:

VIGO System S.A.
129/133 Poznanska St.,
PL 05-850 Ozarow Mazowiecki
Poland



2. VPAC-1000F technical information

The **VPAC-1000F** module consists of:

- Detector TE cooled or uncooled,
- Transimpedance preamplifier optimized for required responsivity and bandwidth.

2.1. Module physical dimensions

M8x1 threaded hole is intended to install the DRB-1 heat sink base.

Dimensions are given in millimeters

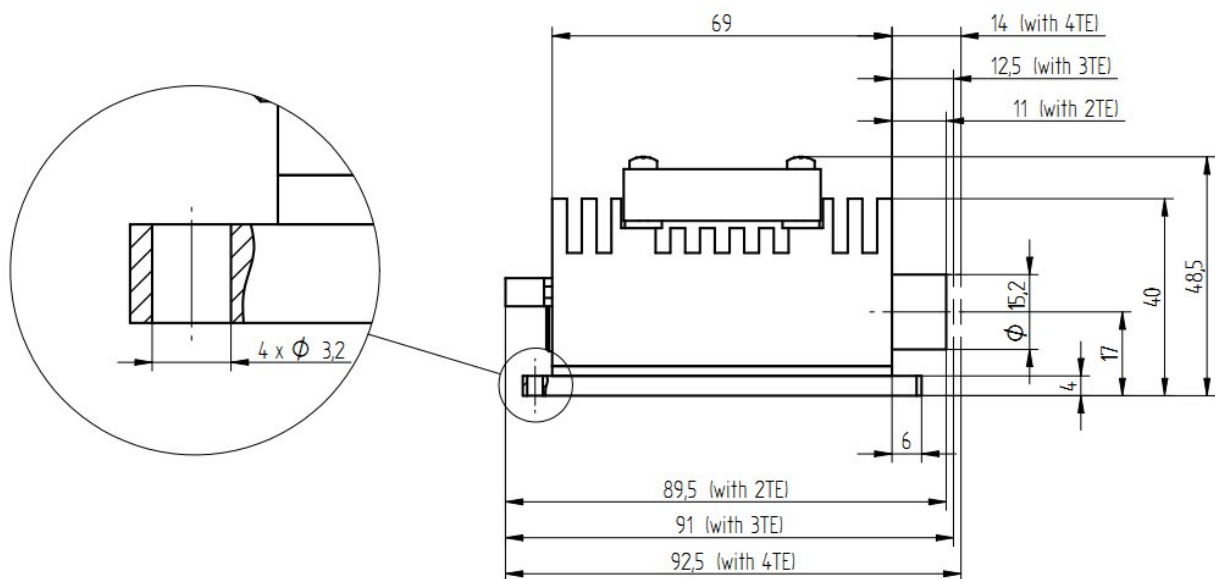
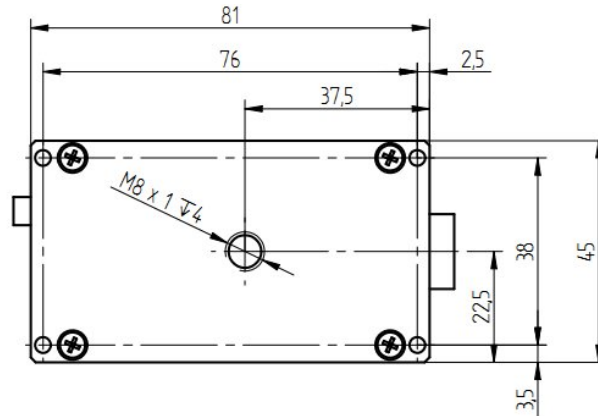

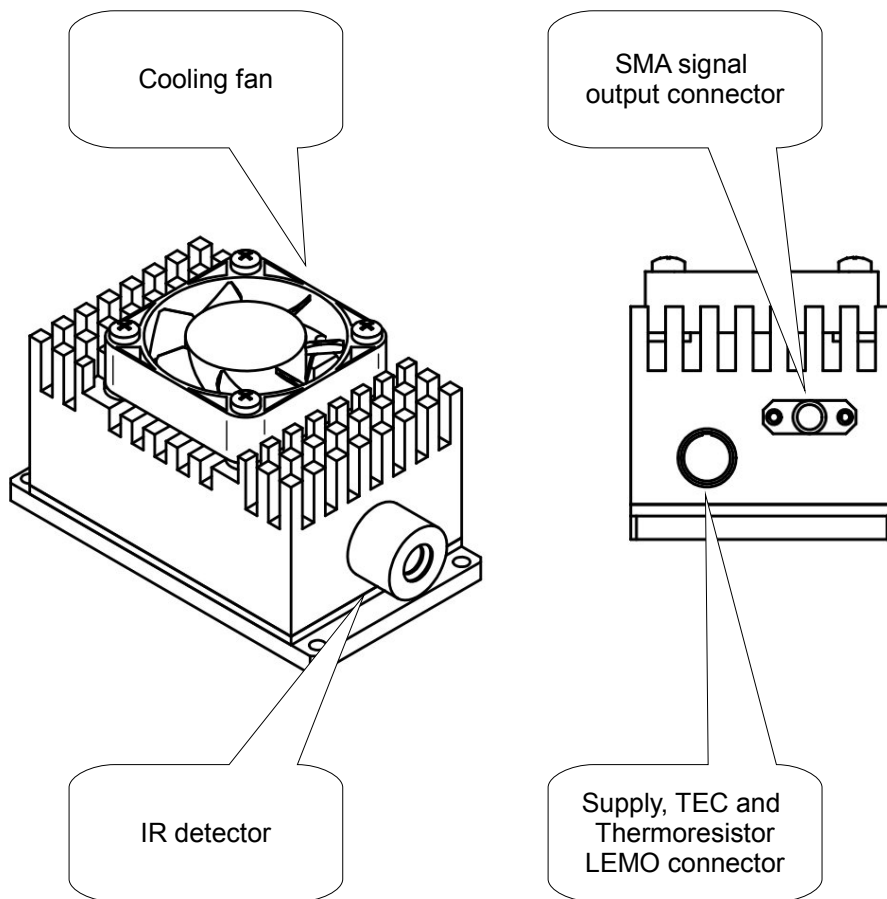

2.2. Beam power limitation

Parameter	IR Detector	
	immersed	without immersion
Maximum continuous optical power	2.5 W/cm ²	100W/cm ²
Maximum optical power of pulses shorter than 1μs	10 kW/cm ²	1MW/cm ²

- For repeated IR radiation with pulses shorter than 1 μs, the equivalent CW irradiation power, averaged over the pulse - to - pulse period, should be less than the CW damage threshold according to equation:

$$\text{equivalent CW radiation} = \frac{\text{pulse peak power}}{\text{detector active area}} * \text{pulse duration} * \text{repetition rate}$$

- Saturation thresholds vary by detector type and can be provided upon request.

2.3. Preamplifier supply voltage

VPAC-1000F module requires + 12 V / - 5 V / 100 mA for supply.

The module is internally protected against reversing the supply polarity and abnormal voltage increase. Although module contains voltage regulators, while powering with the custom made power supply, provide the properly stabilized and filtered voltage.

2.4. Preamplifier load resistance

Load resistance of the VPAC-100F module must be exactly 50 Ω.

Terminating with incorrect load resistance would lead to:

- voltage response that will not match the value given in the datasheet,
- preamplifier pulse response distortion to the line reflection.

2.5. Thermoelectric cooler parameters

Cooler type	Maximum voltage [V]	Maximum current [A]
2-TE (two stage cooler)	1.3	1.2
3-TE (three stage cooler)	3.6	0.45
4-TE (four stage cooler)	8.3	0.5

Shown above parameters matters in case of using VPAC-1000F module in custom made systems. TEC parameters may be changed without notification.

2.6. Thermistor

Thermistor (with the output pins available as TH1 and TH2) is the NTC component (negative temperature coefficient) and it is necessary to lock the temperature control loop-back for keeping the inside temperature constant. The resistance value, when the nominal detector temperature is achieved, is given in the datasheet.

2.7. Supply socket

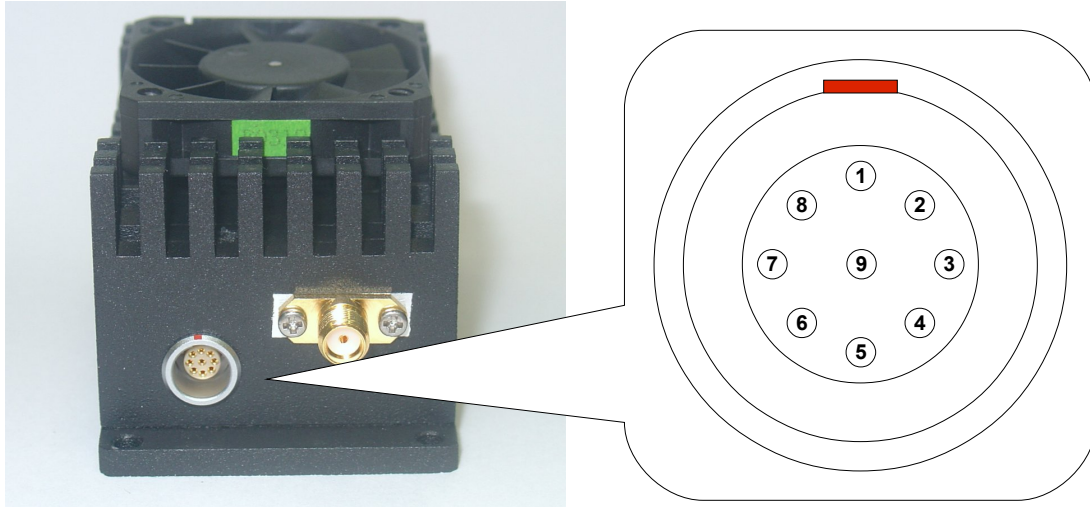

LEMO

Description	Pin number
FAN +	1
Thermistor1	2
TEC+	3
+V _{CC}	4
GND	5
-V _{EE}	6
TEC-	7
Thermistor2	8
Not connected	9

3. Getting started (regards the module itself as well as the complete IR detecting kit)

3.1. Unpacking

Before unpacking, verify if there are no visible damages of the package. Report them to the manufacturer or the distributor.

3.2. Installation & connections

- Mount the IR module in the measurement setup,
- Connect all elements with cables provided in the package,
- Make sure that all the elements are properly connected.

The picture shown below presents sample IR detecting kit configuration with interconnections.

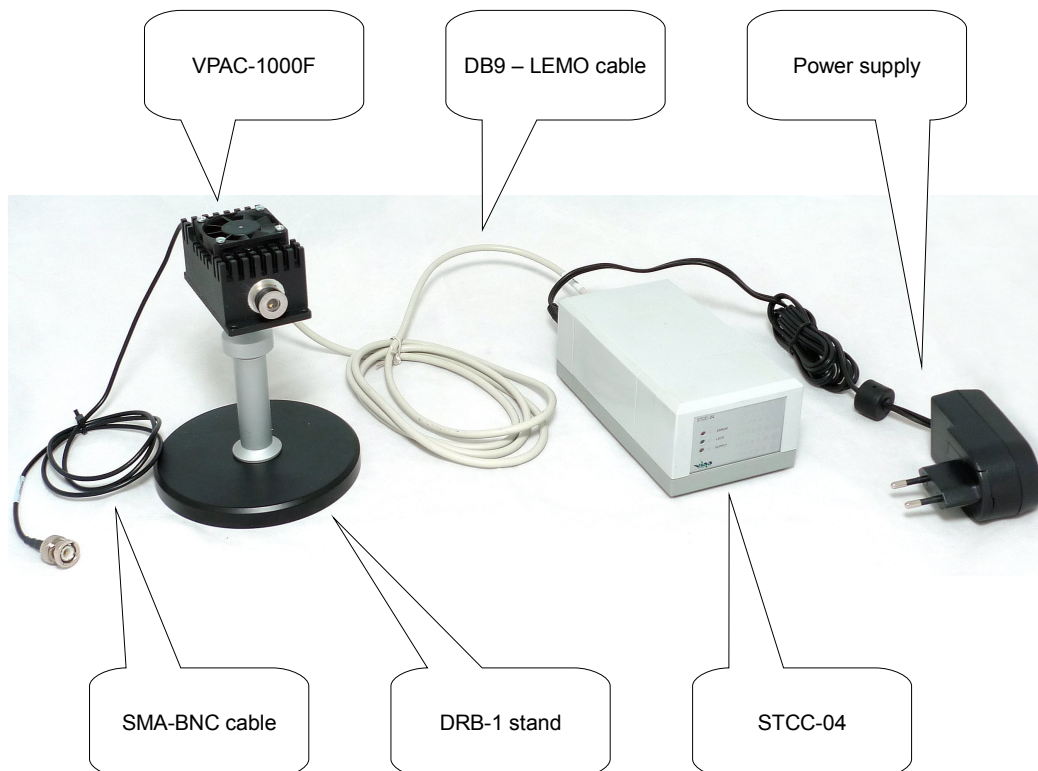

3.3. Switching on procedure

- Do not switch on the IR module power supply until ALL elements of the IR detection kit are properly connected with the proper cables.
- Switch on the thermoelectric cooler controller and wait until detector operating temperature is reached and stabilized. Ready state will be indicated by the „LOCK” green LED light.
- Before starting the measurements make sure the load resistance is valid. The VPAC-1000F output should be terminated by 50 Ω resistance.
- Do not manipulate any connectors on the active IR kit – this may introduce additional noises to the system or can cause severe damages due to electrostatic discharges.

4. VPAC-1000F other related information

4.1. CE statement of conformity

VIGO System declares that IR detection kit is fully compliant with:

EU Low Voltage Directives: 73/23/EEC, 93/68/EEC

EU Electromagnetic Compatibility Directives: 89/336/EEC, 91/263/EEC, 92/31/EEC, 93/68/EEC

4.2. Electromagnetic interference

To avoid the electromagnetic interferences (EMI), please do not put any electromagnetic source close to the IR module. That may cause interference to the input of the preamplifier and disturb the useful signal in the IR track

4.3. Operating temperature and heat sinking

The detector being a part of the module produces heat due to the radiation sensitive structure cooling. Case of the VPAC-1000F module provides complete heat dissipation and doesn't require any additional external radiator nor fan. However, detector specifications are guaranteed for the environment temperature not exceeding 35 °C.















4.4. Storage information

To ensure reliable operation and long lifetime of detector, the following conditions should be fulfilled:

- Storage temperature: -10°C ÷ + 50°C and 10% to 90% humidity
- Avoid exposing to direct sunlight and strong UV/VIS light as this may result in degradation of a detector performance
- Avoid electrostatic discharges (ESD)

5. Safety instructions

To ensure safe and failure-free operation of the IR detection kit comply with the following precautions:

-  The IR module is dedicated to measure IR flux. Never use the module in other applications
-  Never dismount the case or heat sink of the module. Do not open or remove the housing of the device. It may lead to its permanent damage or/and to a risk of electric shock
-  Handle with care, avoid excessive mechanical shock or vibration. Excessive mechanical stress applied to the package itself or to a device containing the package may result in permanent damage. Peltier element used as TEC in thermoelectrically cooled detectors is susceptible to mechanical shocks. Great care should be taken when handling cooled detectors.
-  Use the proper cables to connect elements of the kit, dedicated for specified device only. Never cut or shorten any cable, it may cause damage to your device.
-  Never use cables not approved by VIGO System.
-  Do not replace parts of the IR detection kit - cables, preamplifiers, TEC controllers or detectors. Using parts from other IR detection kit can be the cause of malfunction of your module.
-  Never touch the detector window.
-  Do not insert any objects inwards the vents of the housing. Covering or closing the vents or cooling fan may cause a dangerous rise of the temperature inside the module.
-  All connectors must be connected carefully and firmly.
-  Avoid damp locations. The IR module should be neither installed nor used in high humidity locations.
-  Avoid locations with ambient temperature exceeding module operating temperature. The IR module should not be installed in the proximity of radiators, heat outlets, burners or other heat emitting objects.
-  Use proper ESD protection
-  Ensure stable placement of the device. The IR module should stand on a stable surface.
-  Some IR detector window materials such as BaF₂ are soft. Particular attention should be paid not to scratch the surface of the window. A damaged window may entirely degrade the detector performance.

Important note!

If you are setting up own system based on IR detector module without TEC controller or power supply, please check if the TEC current/voltage and power supply are correct.

6. Troubleshooting

At first, please carefully read the previous parts of this manual, especially Safety Instructions. If a problem persists, please check the information given below.

General Test Procedure

Check:

- Whether components of your IR detection kit are connected correctly,
- Whether connections are snug-tight,
- Whether supply voltages or currents of the components are consistent with the specification,
- Whether an appropriate detector operating temperature is achieved (proper thermistor resistance or indicators on the TEC controller),
- Attenuation/gain factors in your measurement set-up,
- Load resistance at the preamplifier output,
- For high frequency (> 20 MHz) output line, and the load must be matched to the 50 Ohm preamplifier output,
- Whether bandwidths of the components are reasonably well-matched to each other,
- Whether the detector is not saturated or damaged by too high irradiation. Refer to Beam Power Limitations section of this manual. If a problem still exists, try to identify and solve it by actions mentioned below.
- Cycle the power of the components off and on again
- After shielding/switching off the radiation source, do you see any signal decrease? If yes, most probably you see a signal from the optical radiation you hope to see.

6.1. List of the possible faults and solutions

6.1.1. The LOCK LED on the TEC controller's does not light

Follow through General Test Procedure.

Check:

- Thermistor resistance or indicators on the TEC controller,
- Ambient temperature, whether it is not higher than the maximal allowed for a given detector/module operating temperature,
- Supply voltages and currents of the TEC controller,

- TEC controller circuitry and set-point connection,
- detector sealing; is condensation or ice deposition seen on detector element or elsewhere?

If the operating temperature is still higher than expected or the detector package is unsealed, contact your technical support.

6.1.2. Too high DC level at the output of the preamplifier

Follow through General Test Procedure.

Remove the IR source from the detector field of view or decrease incident beam power of your IR source. If device still has high DC level, contact your technical support.

6.1.3. Too high current consumption by the preamplifier

The device is probably damaged, contact your technical support.

6.1.4. No or too weak response to optical radiation

Follow through General Test Procedure.

- Check your radiation source,
- If you do not have any other detector to test your radiation source, move a hot object (ex. soldering iron) rapidly in front of the detector, across its whole field of view. (The higher the temperature of the object or shorter the distance to the detector, the higher the optical signal at the detector output.),
- Test your detector with another available radiation source. A warm or hot object moved in front of the detector can be used for DC or low frequency AC coupled devices,
- Align or improve your optical setup for the maximized signal or signal-to-noise ratio,
- Estimate the detector response, taking into account the incident radiation at the detector active area and the responsivity of the detector (or of the IR detector module), and check it against measured values,
- Evaluate the noise in the system. Calculate the noise introduced by the detector or detection module basing on their noise density from their data sheets. Check it against measured response of the blinded detector,
- Check if the incident radiation will be strong enough to obtain sufficient signal-to-noise ratio. (A signal is easy to pick out of a noise when its peak to peak value is several times greater than of the noise.) If it is lower than expected, consider increasing the incident radiation power on the detector active area,
- Check also if the incident radiation is not too strong, causing detector saturation or damage. If you cannot obtain signal sufficiently higher than noise, contact your technical support.

6.1.5. Excess noise

First of all check through General Test Procedure.

Excess noise may be caused by poor connections, ground connections and ground loops, high background photon flux or EMI (ex. inductive motors driving radiation chopper). You may also decrease the noise by reducing your system bandwidth,

If you are unable to identify external excess noise source, contact your technical support.

6.1.6. Unstable signal

Follow through General Test Procedure.

Check:

- Cables,
- Radiation sources ,
- Whether temperature set-point was achieved (TE-cooled devices),
- If the device is still unstable, contact your technical support.

Warning - DC or low frequency signal may vary due to fluctuations of thermal background radiation

6.1.7. Long signal rise/fall time

Follow through General Test Procedure.

Check:

- The shape of the pulse with another detector if possible,
- The operating conditions (detector temperature, bias, optical setup),
- If impedance of the detector, cables, preamplifier and your read-out instrument are matched.